



Vacuum Packaging Machine

Model VP-NL-0040-MS

Item 42924

Instruction Manual



Revised - 02/25/2022



Toll Free: 1-800-465-0234
Fax: 905-607-0234
Email: service@omcan.com
www.omcan.com



Table of Contents

Model VP-NL-0040-MS

Section	Page
General Information -----	3 - 4
Safety and Warranty -----	4 - 6
Technical Specifications -----	7
Installation -----	7 - 8
Operation -----	8 - 15
Maintenance -----	16 - 20
Troubleshooting -----	21 - 22
Parts Breakdown -----	23 - 25
Electrical Schematics -----	26
Warranty Registration -----	27



General Information

Omcan Manufacturing and Distributing Company Inc., Food Machinery of America, Inc. dba Omcan and Omcan Inc. are not responsible for any harm or injury caused due to any person's improper or negligent use of this equipment. The product shall only be operated by someone over the age of 18, of sound mind, and not under the influence of any drugs or alcohol, who has been trained in the correct operation of this machine, and is wearing authorized, proper safety clothing. Any modification to the machine voids any warranty, and may cause harm to individuals using the machine or in the vicinity of the machine while in operation.

CHECK PACKAGE UPON ARRIVAL

Upon receipt of an Omcan shipment please inspect for external damage. If no damage is evident on the external packaging, open carton to ensure all ordered items are within the box, and there is no concealed damage to the machine. If the package has suffered rough handling, bumps or damage (visible or concealed), please note it on the bill of lading before accepting the delivery and contact Omcan within 24 hours, so we may initiate a claim with the carrier. A detailed report on the extent of the damage caused to the machine must be filled out within three days, from the delivery date shown in the shipping documents. Omcan has no recourse for damaged products that were shipped collect or third party.

Before operating any equipment, always read and familiarize yourself with all operation and safety instructions.

Omcan would like to thank you for purchasing this machine. It's of the utmost importance to save these instructions for future reference. Also save the original box and packaging for shipping the equipment if servicing or returning of the machine is required.

Omcan Fabrication et distribution Compañie Limité et Food Machinery d'Amérique, dba Omcan et Omcan Inc. ne sont pas responsables de tout dommage ou blessure causé du fait que toute personne ait utilisé cet équipement de façon irrégulière. Le produit ne doit être exploité que par quelqu'un de plus de 18 ans, saine d'esprit, et pas sous l'influence d'une drogue ou d'alcool, qui a été formé pour utiliser cette machine correctement, et est vêtu de vêtements de sécurité approprié. Toute modification de la machine annule toute garantie, et peut causer un préjudice à des personnes utilisant la machine ou des personnes à proximité de la machine pendant son fonctionnement.

VÉRIFIEZ LE COLIS DÈS RÉCEPTION

Dès réception d'une expédition d'Omcan veuillez inspecter pour dommages externes. Si aucun dommage n'est visible sur l'emballage externe, ouvrez le carton afin de s'assurer que tous les éléments commandés sont dans la boîte, et il n'y a aucun dommage dissimulé à la machine. Si le colis n'a subi aucune mauvaises manipulations, de bosses ou de dommages (visible ou cachée), notez-le sur le bond de livraison avant d'accepter la livraison et contactez Omcan dans les 24 heures qui suivent, pour que nous puissions engager une réclamation auprès du transporteur. Un rapport détaillé sur l'étendue des dommages causés à la machine doit être rempli dans un délai de trois jours, à compter de la date de livraison indiquée dans les documents d'expédition. Omcan n'a aucun droit de recours pour les produits endommagés qui ont été expédiés ou cueilli par un tiers transporteur.

General Information

Avant d'utiliser n'importe quel équipement, toujours lire et vous familiariser avec toutes les opérations et les consignes de sécurité.

Omcan voudrais vous remercier d'avoir choisi cette machine. Il est primordial de conserver ces instructions pour une référence ultérieure. Également conservez la boîte originale et l'emballage pour l'expédition de l'équipement si l'entretien ou le retour de la machine est nécessaire.

Omcan Empresa De Fabricacion Y Distribucion Inc. Y Maquinaria De Alimentos De America, Inc. dba Omcan y Omcan Inc. no son responsables de ningun daño o perjuicio causado por cualquier persona inadecuada o el uso descuidado de este equipo. El producto solo podra ser operado por una persona mayor de 18 años, en su sano juicio y no bajo alguna influencia de droga o alcohol, y que este ha sido entrenado en el correcto funcionamiento de esta máquina, y ésta usando ropa apropiada y autorizada. Cualquier modificación a la máquina anula la garantía y puede causar daños a las personas usando la máquina mientras esta en el funcionamiento.

REVISE EL PAQUETE A SU LLEGADA

Tras la recepcion de un envio Omcan favor inspeccionar daños externos. Si no hay daños evidentes en el empaque exterior, Habra el carton para asegurarse que todos los articulos solicitados estén dentro de la caja y no encuentre daños ocultos en la máquina. Si el paquete ha sufrido un manejo de poco cuidado, golpes o daños (visible o oculto) por favor anote en la factura antes de aceptar la entrega y contacte Omcan dentro de las 24 horas, de modo que podamos iniciar una reclamación con la compañía. Un informe detallado sobre los daños causados a la máquina debe ser llenado en el plazo de tres días, desde la fecha de entrega que se muestra en los documentos de envío. Omcan no tiene ningun recurso por productos dañados que se enviaron a recoger por terceros.

Antes de utilizar cualquier equipo, siempre lea y familiarizarse con todas las instrucciones de funcionamiento y seguridad.

Omcan le gustaría darle las gracias por la compra de esta máquina. Es de la mayor importancia para salvar estas instrucciones para futuras consultas. Además, guarda la caja original y el embalaje para el envío del equipo si servicio técnico o devolución de la máquina que se requiere.

Safety and Warranty

SAFETY REGULATIONS AND WARNINGS

GENERAL

The manufacturer of this equipment accepts no liability whatsoever for damage or injury caused by failing to adhere to the directions and instructions in this manual, or through carelessness during the installation, use, maintenance and repair of the machine identified on the front of this document, or any of its accompanying options or components.

Safety and Warranty

The owner of the machine is fully responsible at all times for the adherence to the locally applicable safety regulations and guidelines. Obey all safety instructions and guidelines as provided in this manual.

USER MANUAL

- Every user of the machine should be familiar with the contents of this manual and follow its instructions carefully. Management must train the appropriate personnel on the basis of this manual and make sure that all directions and indications are adhered to.
- Never change the order of the actions to be taken.
- Always keep the manual in the proximity of the machine.

PICTOGRAMS AND INSTRUCTIONS ON THE MACHINE

- The labels with pictograms, warnings and instructions that are attached to the machine are part of the safety measures taken. These labels should not be damaged or removed and should remain present and legible throughout the life of the machine.
- Immediately replace or repair any labels that are damaged or have become illegible.

INTENDED USE OF THE MACHINE

The machine is designed for commercial use only for vacuum packaging of food or other products for 8 hours a day, 5 days a week. Any other or extended use is not in accordance with this purpose and the manufacturer accepts no liability for any resulting damage or injury. Only use this machine while in perfect technical condition in accordance with the above mentioned purpose.

TECHNICAL SPECIFICATIONS

The specifications outlined in this manual may not be altered.

MODIFICATIONS

Modifications of the machine or its components is not permitted.

SAFETY MEASURES

The machine is equipped with the following standard safety devices:

- Short-circuit and overload safety.
- Pump fan guards.

All safety devices must be correctly installed and may only be removed to accommodate maintenance and repair activities by trained and authorized service personnel. The machine may never be operated while safety measures are incomplete, deactivated or absent. The safety devices may never be by-passed.

GENERAL PRECAUTION

The vacuum machines must be connected to a grounded, metal, permanent wiring system or an equipment-grounding conductor must be run with the circuit conductors and connected to the equipment-grounding terminal or lead on the product.

For the table top models: “to provide continued protection against risk of electric shock connect to properly

Safety and Warranty

grounded outlets only”.

For all models: “to reduce risk of electric shock and injury to persons, disconnect from power supply before servicing”

RESIDENTIAL USERS: Vendor assumes no liability for parts or labor coverage for component failure or other damages resulting from installation in non-commercial or residential applications. The right is reserved to deny shipment for residential usage; if this occurs, you will be notified as soon as possible.

1 YEAR PARTS AND LABOUR WARRANTY

Within the warranty period, contact Omcan Inc. at 1-800-465-0234 to schedule an Omcan authorized service technician to repair the equipment locally.

Unauthorized maintenance will void the warranty. Warranty covers electrical and part failures, not improper use.

Please see <https://omcan.com/disclaimer> for complete info.

WARNING:

The packaging components are classified as normal solid urban waste and can therefore be disposed of without difficulty.

In any case, for suitable recycling, we suggest disposing of the products separately (differentiated waste) according to the current norms.

DO NOT DISCARD ANY PACKAGING MATERIALS IN THE ENVIRONMENT!



Technical Specifications

Model	VP-NL-0040-MS
Seal Length	19.7" / 500mm
10 Programmable Control	Yes
Busch Vacuum Pump	40 m ³
Maximum Product Height	6.9" / 175mm
Useful Chamber Size	19.7" x 19.7" / 500 x 500mm
Power	4.4 HP / 3.3 kW
Electrical	220V / 60Hz / 1
Dimensions	26.8" x 27.4" x 40.8" / 680 x 695 x 1035mm
Weight	330 lbs. / 149.7 kgs.
Item Number	42924

Installation

GENERAL

- Level the machine on a flat firm surface.
- Position the machine in such a manner that the pump is unobstructed and properly ventilated.
- Engage the locks on the wheels, if so equipped.
- Check the oil level in the pump; add oil if necessary.

Never operate the machine when the oil level is low. It is recommended to change the oil at least every 2 months.

TURNING ON MACHINE

- If so equipped, like some mobile and double-chamber models, turn on the main power switch on the back of the machine.
- Push the on/off button on the control panel of the machine.

GAS CONNECTION FOR MAP APPLICATIONS (MODIFIED ATMOSPHERE PACKAGING)

- Connect the gas supply line to the inlet on the back of the machine.
- Maximum pressure: 1 bar.
- Anchor the gas cylinders securely to prevent them from falling over.
- Make sure that the work area is well-ventilated.
- To assure that you use the appropriate gas for your application, consult your dealer or gas supplier.
- Assure a good connection and use high-quality materials.

COMPRESSED AIR CONNECTION FOR ADDITIONAL SEALING PRESSURE

Installation

- Additional sealing pressure is usually recommended for MAP applications only.
- The models with the option Gas/MAP are standard equipped with a compressed air inlet.
- Extra sealing pressure is not necessary and not available for the Table-Top models.
- Consult your dealer for installation details.
- Maximum pressure: 1 bar.
- Assure a good connection and use high-quality materials.

Operation

TEN-PROGRAM CONTROL SYSTEM

In addition to vacuum and sealing times, machines with a Ten-Program control system may be programmed for several additional functions. Each of the 9 customizable programs is either:

1. Time-controlled.
2. Sensor-controlled

TIME-BASED OPERATION (VACUUM GAUGE: MBAR)

- The values for vacuum and sealing time, as well as the values for several optional functions, are selected by the customer and saved in any of 9 customizable programs P1-9.
- When operating a packaging machine with a time-based program, the actual vacuum pressure is indicated by the analog vacuum gauge. The number of seconds of vacuum time remaining is shown on the LCD display.

PLUG & PLAY

- When turning on a time-based machine for the first time, it will start up in the PA program. This is a pre-set factory program with 30-40 seconds vacuum time and 2 seconds of sealing time.
- When turning on the machine after that, it will start up in the most-recently used program.

OPTIONAL INSTALLATION OF A SENSOR OR SOFT-AIR

- A machine with a time-based control program can be upgraded to sensor-based operation at a later date by installing the optional sensor kit.
- The Soft-Air feature can also be installed at a later date by ordering the optional soft-air kit.

SENSOR-BASED OPERATION (DIGITAL DISPLAY: MBAR)

- When operating a packaging machine with a sensor-based program, the actual vacuum pressure is digitally shown on the LCD display in mbar (standard setting) or in % vacuum.











PLUG & PLAY

- When turning on a sensor-based machine for the first time, it will start up in the PA program. This is a pre-set factory program with 5 mbar of vacuum and 2 seconds of sealing time.









- When turning on the machine after that, it will start up in the most-recently used program.







OPTIONAL INSTALLATION OF SOFT-AIR

- The Soft-Air feature can also be installed at a later date by ordering the optional soft-air kit.

	<p>On: Turns the machine on</p> <ul style="list-style-type: none"> • The machine will start up in the most-recently used program. • The pump of a machine with a transparent cover will start when the cover is closed <p>Off: Turns the machine off</p> <ul style="list-style-type: none"> • When pressing the  button once, the  symbol will start blinking and the pump will stop after about 4 seconds. • When pressing the  button a second time, the pump will stop immediately. • Closing the cover will initiate the cool-down phase. • The machine will complete a number of vacuum cycles before turning off automatically.
	<p>Stop-function</p> <ul style="list-style-type: none"> • Stops the machine at any point in the cycle and aerates the chamber. <p>Reset-function</p> <ul style="list-style-type: none"> • While programming, resets the program value to its original setting. • Press the menu button  to return to the Home menu. <p>Back function</p> <ul style="list-style-type: none"> • While reviewing programmed values, returns to the previous selection.
	<p>Stops the active function and initiates the next step in the cycle</p> <ul style="list-style-type: none"> • While the machine is running, exits the active function and jumps to the next step in the cycle. • While packing sauce or soup, the package may be sealed as soon as product boiling is detected.
	<p>Menu Button</p> <ul style="list-style-type: none"> • Toggles between Home menu  and Settings menu . • Save Function: During programming, confirms and saves the entered program values and returns to the Home menu. • Return Function: Returns to the Home menu.
	<p>Review program values</p> <ol style="list-style-type: none"> 1. Cycles through programs P1 to P9, as well as PA and P H2O. 2. Displays the programmed value for each function; the function being reviewed will be blinking. 3. Displays the value for the next function. 4. Returns to the Home menu.

Operation

	<p>Adjust program values and turn functions ON/OFF</p> <ol style="list-style-type: none"> 1. Forward or back; adjusted values are saved right away. 2. Increases or decreases function values. 3. Turns functions ON/OFF; specific functions, like soft-air, clean cut seal, etc., are turned either on or off. 4. If the function is turned on, the value may be adjusted by pressing the and buttons. 5. Resets the original value. 6. Saves changes and returns to the Home menu.
	<p>Multi-Functional button: Performs various functions, depending on the active menu</p> <p>Home menu:</p> <ul style="list-style-type: none"> • No effect while in the PA program. • For programs P1-9, displays the entered values. <p>Settings menu:</p> <ul style="list-style-type: none"> • For specific functions, like soft-air, clean cut seal etc., the  button is used to turn the function ON/OFF.
<p>P1 – P9</p>	<p>Programs 1 through 9</p> <ul style="list-style-type: none"> • Each program may be customized by turning certain functions on or off and by adjusting the function values.
<p>PA </p>	<p>PA - Automatic</p> <ul style="list-style-type: none"> • Program with factory settings for vacuum and sealing functions, which is activated when turning on the machine for the first time.
<p>P H2O</p>	<p>P H2O – Program</p> <ul style="list-style-type: none"> • To be used when packing liquids or semi-liquids, like sauces and soups. • Program jumps to the sealing function as soon as product boiling is detected; this prevents product loss through spillage and evaporation.
	<p>When turning off the machine with the  button, the  symbol will start blinking on the LCD display</p> <ul style="list-style-type: none"> • The pump will stop after about 4 seconds. • Press the  button for a second time and the pump will stop immediately. • Close the lid; the machine will initiate the cool-down phase and perform a number of vacuum cycles before turning off automatically. • These additional cycles allow any moisture in the oil of the pump to evaporate. This increases the longevity of the machine and minimizes the need for oil changes and pump maintenance.

	<p>Service Symbol</p> <ul style="list-style-type: none"> • After reaching a certain number of operating hours or packing cycles, the service symbol will briefly appear on the display when turning on the machine. In addition, the display indicates how many hours or cycles remain before an oil change is required. • Except for regularly changing the oil in the pump, the machine requires little other routine maintenance. • After reaching the service limit, the display will indicate the negative number of exceeded operating hours or cycles. • To reset the service interval counters after the oil change: Start machine  and while the display shows the hours or cycles, press and hold the  button.
	<p>PAP program (optional)</p> <ul style="list-style-type: none"> • Vacuum will be applied. The product will be under vacuum for a maximum of 5 minutes before the pouch is sealed.
	<p>Marinating program (optional)</p> <ul style="list-style-type: none"> • Marinade will infuse deeply into the product by continuously increasing and decreasing the pressure during the vacuum cycle.
	<p>Red meat program (optional)</p> <ul style="list-style-type: none"> • Fresh meat, such as steak, will be put under vacuum and sealed and aired immediately after. This avoids extraction of moisture from the meat that would otherwise accumulate around the product.

PROGRAMMING THE MACHINE

TEN-PROGRAM CONTROL SYSTEM

- The Ten-Program control system is standard time-based on the machines.
- Sensor-based operation is an option, which can be installed at a later date
- The Ten-Program control system provides:
 - 9 customizable programs (P1-P9).
 - Program PA; this is an Automatic Program pre-set at the factory at a vacuum time of 30-40 seconds (or 5 mbar for a sensor-based program) and a sealing time of 2 seconds.
 - Program P H2O for liquid products.
- When turning on the machine, the pump will start. After about 15 minutes of inactivity, the pump will stop automatically.

PROGRAMMABLE FUNCTIONS

The following functions may be customized for each program P1-P9:

 Vacuum time: in seconds or mbar (only with sensor)

 Sealing time: in seconds.

 Vacuum Plus: on/off, in seconds.

 Gassing: on/off, in seconds or mbar (only with sensor).





Operation

 Clean Cut Controlled (CCC) Seal: on/off, in seconds







 Soft-Air: on/off, in seconds or mbar (only with sensor)

 Multi-cycle: on/off, in number of cycles

REVIEWING FUNCTION VALUES FOR P1-P9

1. Turn the machine on by pushing the  button.
2. The most-recently used program will be indicated.
3. All selected functions for this program are indicated at the bottom of the display.
4. To review the values for these functions, push the  button; use the  button to display each function value.
5. The values cannot be changed; this can only be done in the Settings menu.
6. Push the  button to return to the Home menu.

PROGRAMMING AND ADJUSTING VALUES FOR P1-P9

1. Select the program to be set up or adjusted.
2. Push the menu button  to access the Settings menu.
3. All functions for the selected program are indicated at the bottom of the display.
4. Push the  button to select the blinking function to be adjusted.
5. Adjust the value of the selected function with the  button.
6. Press the  button to reset all functions to their original values.
7. Select the next function with the  button.
8. Press the menu button  to save the entered values and to return to the Home menu.

TURNING PROGRAM FUNCTIONS ON/OFF

The following functions can be turned ON/OFF for each program P1-P9:

 Vacuum Plus: on/off, in seconds





 Gassing: on/off, in seconds or in mbar (only with sensor)



 Clean Cut Controlled (CCC) Seal: on/off, in seconds

 Soft-Air: on/off, in seconds or in mbar (only with sensor)



 Multi-cycle: on/off, in number of cycles

ADJUSTING ON/OFF FUNCTION VALUES

1. Press the menu button  to select the Settings menu.
2. Use the  button to select the blinking function to be adjusted.
3. For instance, the gassing function is turned off. Press the  button to turn this function on.
4. Press the  button to select the desired value, for instance 180 mbar.
5. Press the  button to reset all functions to their original values.

6. Select the next function with the  button
7. Push the menu button  to store all selected values and to return to the Home menu.

TURNING OFF MACHINE

1. Turn the machine off by pressing the  button.
2. The  symbol on the display will start blinking.
3. Push the  button a second time and the pump will stop immediately.
4. If no action is taken the pump turns off after 4 seconds.
5. Close the cover and the machine will initiate the cool-down phase and perform a number of vacuum cycles while the cover stays closed and the machine will turn off automatically after about 15 minutes

Note: These cycles are necessary to cool down the machine and to allow any moisture in the oil of the pump to evaporate.

FURTHER EXPLANATION OF PACKAGING CONCEPTS

SENSOR-BASED CONTROL

The actual air pressure in the chamber is measured by a sensor. The result of this measurement is digitally indicated on the LCD display.

Normal air pressure is about 1000 mbar. The vacuum pump of the machine reduces this to about 2-5 mbar. Depending on the program, the pressure by which certain functions need to take place can be programmed. Examples are MAP gassing and Soft-Air. The air pressure in time-controlled machines is indicated by the analog vacuum gauge.

TIME-BASED CONTROL

- The standard control of a One-Program machine, as well as a Ten-Program machine, is time-based.
- The Ten-Program time based machine can be converted into sensor-based operation by ordering the optional sensor kit.

A time-controlled machine is programmed with a time value in seconds, according to which a desired vacuum is reached. The vacuum measurement is indicated by the analog vacuum gauge. The reading of the analog vacuum gauge is less accurate than the digital reading of a sensor-controlled machine.

- The Ten-Program machine can be retro-fitted with a sensor kit at a later date. The control system recognizes the sensor and will automatically switch over to sensor-based operation.
- In case the sensor should fail, the machine will automatically switch over to time-based operation.

PH2O PROGRAM FOR LIQUID PRODUCTS

- Only for Ten-Program machines with sensor-based control.
- Specially designed for the packaging of cooled liquid products like sauces and soups at temperatures < 150C (600F).

Under normal air pressure (1000 mbar), water boils at 100°C. At that point, water transfers rapidly from a liquid phase to a gas phase. At lower air pressure, boiling starts at a lower temperature as well as rapid evaporation. To avoid product loss through evaporation and spillage, the P H2O program detects the point of boiling and

Operation

initializes sealing function in the cycle. Since air is replaced by water vapor at this point, the oxygen content in the package will be very low.

VACUUM PLUS

- Only for Ten-Program machines with sensor-based control.
- Can be turned on or off in the Settings menu.

After reaching a programmed vacuum pressure, the sealing function may be delayed by adding a programmable number of seconds to the vacuum process. This enables any air to escape from porous products.

MAP GASSING (OPTION)

- Only for Ten-Program machines with sensor-based control.
- Can be turned on or off in the Settings menu.

After reaching a programmed vacuum pressure, the package is filled with an inert gas, such as CO₂, nitrogen, oxygen, or a mixture thereof. This feature is either time or pressure-controlled.

SEALING

The synthetic packaging material is melted shut by a heated sealing wire.

EXTRA SEALING PRESSURE

During the sealing process, the package is held in place between the seal beam and the counter beam. To assure a proper package seal, additional air pressure to the sealing beam may be beneficial (maximum of 1 bar), for instance during MAP gassing above 500 mbar.

- The models with the option Gas/MAP are standard equipped with a compressed air inlet. Otherwise it can be easily retrofitted.
- Extra sealing pressure is not necessary and not available for the Table-Top models.

SOFT-AIR (OPTION)

- Only for Ten-Program machines with sensor-based control.
- Can be turned on or off in the Settings menu.

After the vacuum and sealing process, the chamber is aerated and brought back to ambient air pressure. Since this happens quickly, the packaging material conforms to the product quickly as well. If the product has sharp edges, the packaging material may be punctured during this process. With the Soft-Air feature, air is introduced into the vacuum chamber in a slower and controlled manner. As a result, the packaging material gradually conforms to the product, thus avoiding damage. This feature is either time or pressure-controlled. Machines with a Ten-Program control system can be retro-fitted with this feature.

MULTI-CYCLE

- Only for Ten-Program machines with sensor-based control.
- Can be turned on or off in the Settings menu.
- Only in combination with MAP gassing

This option minimizes the amount of oxygen in the product. The machine vacuates and gases the package several times in a row, thus flushing air and oxygen from the chamber and the package. This feature is used for delicate products that do not permit vacuation down to 5 mbar, while at the same time requiring a low oxygen content.

COOL-DOWN/OIL DEHUMIDIFICATION OF THE VACUUM PUMP

During the vacuum process, moisture is removed from the product through evaporation. This moisture can be absorbed by the oil of the vacuum pump. Too much moisture in the oil will reduce the effectiveness of the pump. In addition, it will reduce the lubrication properties of the oil, affecting the longevity of the pump. Heat and ventilation will dissipate this moisture, for which reason it is important to let the pump run for some time at the end of production.

- Turn the machine off with the button and close the cover when the symbol starts blinking. The pump will continue to run for some time, before turning off automatically. This allows any moisture in the oil of the pump to evaporate.

“PAP” PROGRAM (OPTION)

This option is only available with sensor control.

This program keeps the vacuum chamber under vacuum for a maximum of 500 seconds before the package is sealed. This program was developed to quickly tenderize meat under the influence of enzymes (patented in Japan). Time and vacuum level are adjustable.

“RED MEAT” PROGRAM (OPTION)

This option is only available with sensor control.

Depending on the moisture content of the meat, a layer of moisture will be visible around the meat after vacuum packaging. This program will limit moisture loss from the meat, depending on the kind of meat. In some cases, this can be of importance for the visual appeal of the meat. Right before sealing the package, the vacuum chamber will be aired briefly. This time is adjustable (0,1-1 sec). This does not affect the vacuum inside the packaging.

“MASSAGE” OR “MARINATING” PROGRAM (OPTION)

This option is only available with sensor control. Upon activating this program the arrows and dots will flicker.

With this program, marinade is deeply infused into the meat, which is sped up by the vacuum. During the cycle, the vacuum is increased and decreased a couple of times so that the pressure on the meat fluctuates, creating a pumping effect. The number of cycle and the vacuum level of the cycles can be adjusted and determines how quickly the marinade infuses into the meat.

Maintenance

GENERAL

Regular maintenance prevents equipment malfunctions and prolongs the life of the machine. In addition, it optimizes sanitary conditions.

- Always have a certified Omcan dealer carry out repair and maintenance activities.

WARNING

- During maintenance activities, always turn the machine off at the main switch and/or unplug it from the electrical outlet.

ATTENTION

Observe the recommended service intervals. Overdue maintenance may lead to costly repairs and overhauls, and may void the equipment warranty.

- After reaching a programmed number of operating hours or packing cycles, the service symbol will briefly appear on the display when the machine is started up. In addition, the display will indicate how many hours or cycles remain before an oil change is required.
- After passing the service limit, the display will indicate the negative number of excess operating hours or cycles.

VACUUM PUMP

To protect the vacuum pump, proper maintenance is important. Carry out the following tasks carefully:

- Check the vents and clean as necessary before turning on the machine to assure proper cooling of the pump.
- When the air filter is saturated with oil, an oil mist may be expelled; replacement of the filter is required.
- Use the cool-down/dehumidification feature. When turning off the machine and closing the cover, the pump continues to run for some time. Any moisture in the oil of the pump will evaporate during this phase. This increases the longevity of the machine and minimizes the need for oil changes and pump maintenance.
- Check the oil level regularly and add as needed.
- Change the oil when the service symbol appears on the display.

NOTE

- To reset the service interval counters after the oil change: Start machine and while the display shows the hours or cycles, press and hold the X button.

ADDING AND CHANGING THE PUMP OIL

WARNING

The operating temperature of the pump is 70°C / 158°F or higher. Wear gloves when servicing the pump or let it cool off sufficiently to prevent injuries.

ADDING OIL

1. Remove the oil filler cap.
2. Add oil up to the maximum-level mark; use oil according to DIN 51506, lubrication oil group VC; See 'Technical Specifications' for additional information. When in doubt, consult your dealer.

3. Replace the oil filler cap.
4. After several packing cycles, check the oil level and add as needed.

CHANGING OIL

1. Remove the oil drain plug and drain the oil.
2. Replace the drain plug.
3. Remove the oil filler cap.
4. Add the correct oil up to the maximum-level mark.
5. Replace the oil filler cap.
6. To reset the service interval counters after the oil change: Start machine and while the display shows the hours or cycles, press and hold the X button.

NOTE

Collect the oil to have it processed and recycled according to the locally applicable regulations.

SEAL BEAMS AND COUNTER BEAMS

To achieve a quality seal, it is necessary that the seal beam and counter beam are in good condition.

1. Clean the seal and counter beams daily with a dry cloth.
2. Replace the Teflon tape on the seal beam if damaged and replace the sealing wire if kinked.
3. Replace the silicone rubber seal if it is burned in.

Depending on the type of machine, there are three seal beam versions:

1. Single-seal beam (T2).
2. Stainless steel seal beam.
3. Aluminum seal beam.

SINGLE-SEAL BEAM

REMOVE THE SEALING WIRE AND TEFLON TAPE AS FOLLOWS:

1. Grab the seal beam in the middle and pull it straight up and out of the machine.
2. The beam is held in place by 2 pins; some force may be necessary to loosen the beam.
3. Remove the brown Teflon tape (A) that is applied to the seal beam.
4. Remove the two screws (F) on the underside of the seal beam; this releases the sealing wire (B).
5. Clean the seal beam thoroughly and remove any glue residue of the Teflon tape.

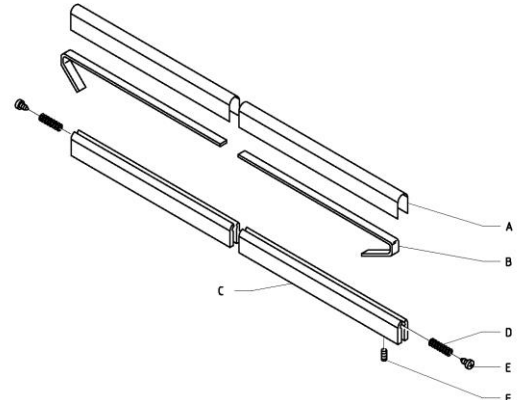

NOTES

- Check the condition of the tensioning springs (D) at both ends of the seal beam; replace if necessary.
- These springs maintain tension on the sealing wire.
- Using the seal beam without the springs may cause sealing wires to break.

Maintenance

INSTALL THE SEALING WIRE AND TEFLON TAPE AS FOLLOWS:

1. Position the sealing wire across the beam and fasten it on one side with a small bolt.
2. Apply tension on the wire by pulling it with a pair of pliers.
3. Fasten the wire on the opposite end of the beam with the second bolt and cut the wire to length; the ends of the sealing wire must be long enough to make electrical contact with the pins in the vacuum chamber.
4. Apply the Teflon tape smooth and tight over the seal beam; make sure that the beam is clean and free of grease.
5. Re-install the beam in the vacuum chamber; check to make sure that the ends of the sealing wire make contact with the steel pins.

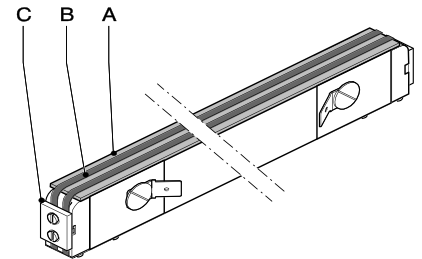

ALUMINUM/STAINLESS STEEL SEAL BEAM

REMOVE THE SEALING AND CUTTING WIRES AS FOLLOWS:

1. Remove the old wires by pulling them loose from the seal beam contacts.
2. Loosen the clamp screws and remove the seal beam from the U-profile.
3. Remove the Teflon tape from the seal beam.
4. Remove the mounting plates (C) on both ends of the seal beam by loosening the screws; this releases the sealing wires (B) and/or sealing and cutting wires.
5. Clean the seal beam thoroughly.

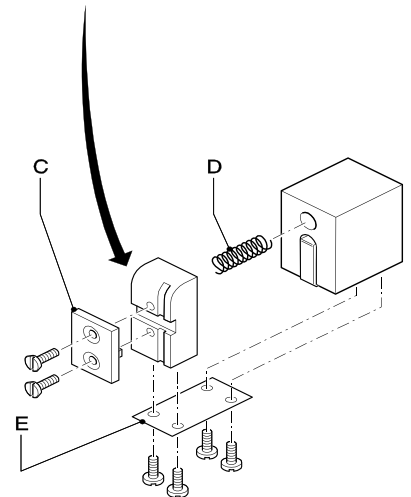

NOTES

- After removal of the wires, check the strips of fiber glass (A) for damage; replace if necessary.
- Check the condition of the tensioning springs (D) at both ends of the seal beam; replace if necessary.
- Using the seal beam without the springs may cause the sealing wires to break.
- Check contact plate (E) for damage; replace if necessary.

INSTALL THE SEALING AND CUTTING WIRES AS FOLLOWS:

1. If necessary, install new strips of fiber glass on the seal beam.
2. Insert the new wires (B) behind one of the mounting plates (C) and tighten the screws (D); make sure that the end of the wires line up with the bottom edge of the mounting plate.
3. Position the wires across the seal beam and loosely install the second mounting plate.
4. Carefully clamp the seal beam upside down in a bench vice.
5. Pull the wires as tightly as possible with a pair of plier (A) and secure the second mounting plate (D) by tightening the screws.

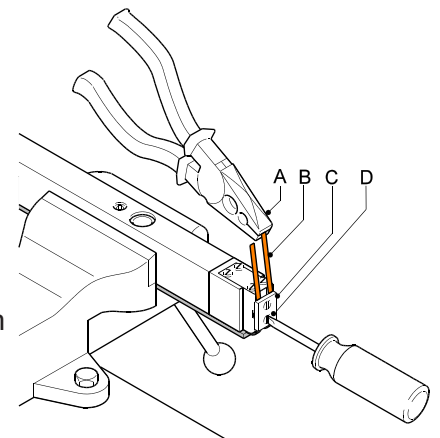

NOTES

1. The wires can be further tightened by slightly loosening the screws of one of the mounting plates.
2. Pull the wires one-by-one tighter with a pair of pliers.

3. Re-tighten the screws after the correct tension has been achieved.
4. Cut the end of the wires flush with the bottom edge of the mounting plate.
5. Apply the Teflon tape smooth and tight over the seal beam without creases. Make sure that the beam is clean and free of grease.
6. Re-install the seal beam in the vacuum chamber and re-connect the wires.

ALUMINUM T-SHAPED SEAL BEAM

REMOVE THE SEALING WIRES AS FOLLOWS:

1. Remove the seal beam from the machine.
2. Remove the Teflon tape.
3. Loosen the screws (D) on both sides of the beam; this will release the sealing wires (B).
4. Clean the seal beam thoroughly.

INSTALL THE SEALING WIRES AS FOLLOWS:

1. Apply new fiber glass (A) to the beam if necessary.
2. Place new wires (B) on the beam and fasten them on one side with mounting plates (C); tighten the screws (D).
3. Position the wires across the beam.
4. Fasten mounting plates (C); tighten screws (D).
5. Carefully clamp the beam in a bench vice.
6. Pull the wires as tightly as possible with a pair of pliers.
7. Secure the mounting plates (C) with the screws (D).

NOTES

- Check the strip of fiber glass(A) for damage and replace if necessary.
- Check the springs and replace if necessary.
- Using the seal beam without the springs may cause the sealing wires to break.

APPLYING TEFLON TAPE TO SEAL BEAM

1. Position the new Teflon tape (A) on the seal beam.
2. Cut out the corners (C).
3. Remove the protective backing from the Teflon tape.
4. Apply the new tape to the seal beam (B); the tape has an adhesive strip on both sides.
5. Slide the seal beam onto the pins in the vacuum chamber (machines with transparent cover).
6. Slide the seal beam in the holder of the cover, tighten the mounting screws, and re-connect the wires (machines with metal cover).

NOTE

- The Teflon tape must not adhere to the tension blocks (E).

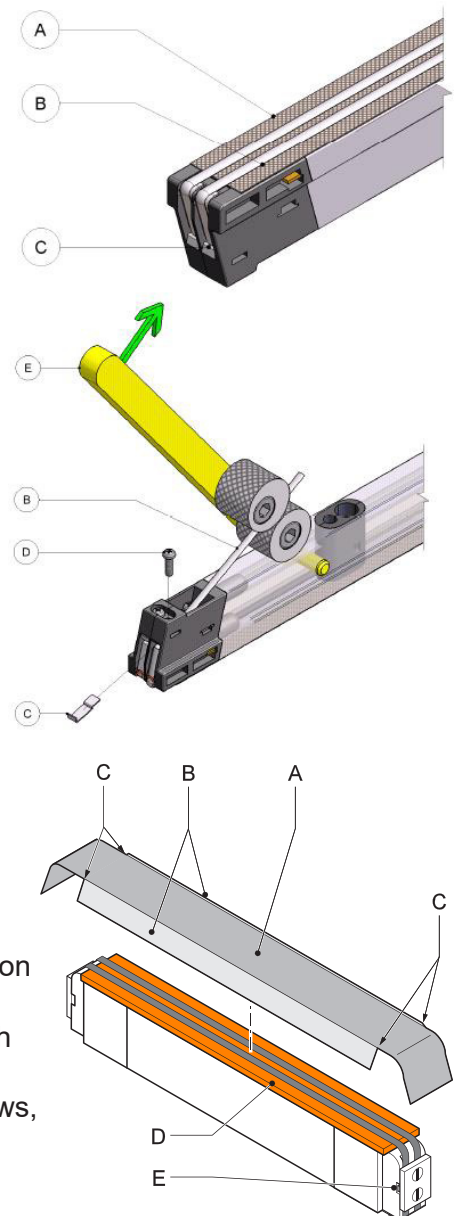

Maintenance

REPLACING SILICONE RUBBER SEAL OF COUNTER BEAM

The rubber seal is clamped in the counter beam.

REPLACE THE COUNTER BEAM SEAL AS FOLLOWS:

1. Pull the old rubber seal from the groove in the counter beam.
2. Clean the groove.
3. Evenly press the new rubber seal into the groove and make sure that it does not stick out at either end of the counter beam.

RUBBER SEAL OF VACUUM CHAMBER COVER

To assure that the vacuum chamber is properly sealed, it is important that the rubber seal is in good condition and is not damaged.

REPLACE THE COVER SEAL AS FOLLOWS:

1. Copy the length of the original rubber seal.
2. Pull the original rubber seal from the groove.
3. Clean the groove.
4. Evenly press the rubber seal into the groove; position the ends of the seal tightly against each other to prevent leakage.

STRUTS, DAMPERS AND SPRINGS

- Machines with transparent covers are equipped with gas struts to open the cover.
- Machines with metal covers are equipped with oil dampers and springs to open the cover.
- Have the struts, dampers and springs checked by your dealer once every 5 years and have them replaced as necessary.
- Have the gas struts replaced if the lid no longer opens properly.

VACUUM HOSES AND TUBES

- Check the vacuum hoses and tubes for kinks, tears and porosity; replace if necessary.

Troubleshooting

Fault/Symptom	Possible Cause	Remedy
Machine does not work.	The machine is not plugged in.	Plug the machine into the electrical outlet.
	The ground fault safety in the electrical panel has tripped.	Check the electrical panel.
	A fuse in the electrical panel is faulty.	Check the electrical panel.
	A fuse in the machine is faulty.	Consult your dealer.
	The motor protection of the machine is switched off.	Consult your dealer.
The vacuum pump does not run at full speed.	The oil is too thick or contaminated.	Change the oil.
	The pump motor runs on two phases.	Check the voltage; if correct, consult your dealer.
The vacuum in the package is insufficient.	The programmed vacuum value is too high.	Lower the vacuum value in the program.
	The packaging material is of poor quality.	Select a better-quality packaging material.
	The product damages the bag.	Program a higher value for Soft-Air.
	The machine gases the package.	Turn off the gassing function.
The seal is leaking.	The package seam is poorly formed.	Increase the sealing time and/or reduce the MAP gas pressure.
	The package seam is burnt.	Decrease the sealing time.
	The opening of the vacuum bag is contaminated.	Try again and make sure that the opening of the bag stays clean.
	The sealing beam is dirty.	Clean the sealing beam.
	The Teflon lining of the sealing beam is damaged.	Replace the Teflon lining.
	The silicon rubber seal in the counter beam is damaged.	Replace the silicon rubber seal.
There is not enough gas in the bag.	The bag is too small.	Select a bigger bag.
	The programmed gas level is too low.	Increase the gas level value.
	The bag is not correctly positioned over the gas outlets.	Adjust the bag position.

Troubleshooting

The machine does not seal.	The bag is not correctly positioned over the sealing beam.	Adjust the bag position.
	The sealing wire is broken.	Replace the sealing wire.
	The thermal safety of the power supply was tripped.	Wait until the safety resets, which can take half an hour. Decrease the sealing time.
	The electrical contacts of the seal beam have fouled.	Remove the seal beam and clean the pins and contacts with sand paper.
The service symbol appears when turning on the machine, indicating the remaining production hours or cycles.	The service interval counters have reached their maximum programmed values.	To reset the service interval counters after the oil change: Start machine and while the display shows the hours or cycles, press and hold the X button.

Parts Breakdown

Model VP-NL-0040-MS 42924

Item No.	Description	Position	Item No.	Description	Position	Item No.	Description	Position
35230	Vacuum Chamber Complete for 42924	0010	15716	3-Way Valve 2000500 for 42924	0260	35290	Sight Glass 200 (380x280x20) for 42924	1020
35231	Branch Pipe HFE-1 Ready for 42924	0020	30015	Square Hose Coupling 1/4"x6 EXT. for 42924	0270, 0360	35105	Sil.Profile Lidgasket 8mm 60 SH/25MTR for 42924	1030
35232	O-Ring 32x3 for 42924	0030	35261	Brass Hose Coupling 1/4"x8 EXT. for 42924	0350	35292	Lid Locker Hook V95117-1BP for 42924	1040
35233	Filter for 42924	0040	15775	Micro Switch MV3003L for 42924	0370	35293	Slotted Cheese Head Screw M3x5 A2 DIN84 for 42924	1050, 4170
35234	Adj.Screw/Soc.Head M8x30 DIN916 A2 for 42924	0050	27823	Hexagon Nut M3 DIN934 A2 for 42924	0380	35295	Rodend Hinge Cover for 42924	1070
27814	Hexagon Nut M8 DIN934 A2 for 42924	0060, 4065, 5100	27822	Castle Washer M3 for 42924	0390, 4165	27808	Adjusting Fork for 42924	1080
35236	Spring Ring M8 DIN127 A2 for 42924	0070	35266	Distance Bush PCB Main for 42924	0395	27809	Adjusting Fork Closing Pin for 42924	1090
35237	Hex.Socket Head Cap Screw M5x30 DIN912 A2 for 42924	0080	30011	Slotted Cheese Head Screw M3x20 A2 DIN84 for 42924	0400	35298	Cable Gland M20x1.5 Brass for 42924	1160, 4070
15722	Vac.Valve without Decomp.Head 32mm for 42924	0090	27781	Hexagon Flangenut M6 DIN6923 A2 for 42924	0420, 0460	35299	Handle GN-565-26-192-SW 800 for 42924	1200
15723	Decompress Head Vacuum Valve 32mm for 42924	0100	27788	Adj.Screw/Soc.Head M6x25 DIN916 A2 for 42924	0430, 1060	35300	Hexagon Screw M8x20 DIN933 A2 for 42924	1210
35240	Support Gas Cylinder for 42924	0110	35270	Adj.Screw/Soc.Head M6x20 DIN916 A2 for 42924	0450	35301	Castle Washer Red Copper M8 for 42924	1220
35241	Support Microswitch MV3000 for 42924	0115	35272	Hex.Socket Head Cap Screw M5x8 DIN912 A2 for 42924	0470	35302	Mounting Plate 160x455x5 for 42924	2000
35242	Packing Branchpipe Mobiles for 42924	0120	35273	Hingepin for 42924	0480	15792	Combi-Trafo P200/460V-S24/32V for 42924	2020
15756	Gascylinder 1000320 (1X) for 42924	0130	35274	Spring Collar for 42924	0490	35304	Earth Terminal PE 4-2/3 for 42924	2030
35244	Hexagon Screw M6x25 DIN933 A2 for 42924	0135	35275	Safety Pin Hinge for 42924	0500	35305	End Fent for 42924	2050
35245	Hexagon Nut M6 DIN934 A2 for 42924	0140	35276	Spring Ring 12mm DIN471 for 42924	0510	35306	Fuse Clamp 2.5-2/ZSI for 42924	2060
27786	Flat Washer M6 D9021 A2 for 42924	0150, 4310	27827	Flat Washer M10 D9021 A2 for 42924	0520	35307	Zekering Keram.5x20 2.5A TRAAG for 42924	2070
35247	Blindstopper + O-Ring 1/4" MS/VN for 42924	0170	27826	Adj.Screw/Soc.Head M10x50 D916 A2 for 42924	0530	15818	Fuse 5x20 4A Slow for 42924	2075
35248	Hose Coupling 1/2"x10 EXT. for 42924	0180	35279	Selflocking Hexagon Nut M10 DIN985 VZ for 42924	0540	15817	Fuse 5x20 8A Slow for 42924	2076
35249	Elbow Coupling 10x1/4" for 42924	0190	27819	Square Hose Coupling 1/8"x6 EXT. for 42924	0550	15784	TMBR AB193-TAB40 2 4-4 0A for 42924	2080
35250	Gas Nozzle Universal for 42924	0200	15751	Decompress Filter 1/2" for 42924	0570	15785	TMBR AB193-TAB60 4 0-6 0A for 42924	2081
35251	Hexagon Nut M8x1 Low DIN439B for 42924	0205	35282	T-Screw-In Hose Coupling 1/8"x6 EXT. for 42924	0580	15786	TMBR AB193-TAC10 6 0-10 0A for 42924	2082
35252	Gas Valve for Gas Distribution for 42924	0210	35203	Plug Plastic 1/8" for 42924	0810	15787	TMBR AB193-TAC16 10 0-16 0A for 42924	2083
35253	Closing Plug Silicon Holder for 42924	0220	35284	Extension Piece Oil Drain for 42924	0820	15781	TMBR AB193-TAPM Montage Sokkel for 42924	2085
35254	Reducing Nipple 1/2"x3/8" for 42924	0230	35285	Valve 2/2 MA-222-003-P27-SAH 24 for 42924	0830	35315	Double Clamp 2.5-2 for 42924	2090
35255	Distribution Block 4DVB/VP 3/8-1/4-4 for 42924	0240	35205	Brass Double Nipple 1/8" for 42924	0840	15771	Closed Contactor 24VAC for 42924	2110
35256	Air Pressure Hose Blue 10x8 for 42924	0245	35225	Silencer ID-CL 1/8 for 42924	0850	35317	Earth Terminal PE 6-10 for 42924	2130
35257	Insert Coupling Straight 1/4"x10 for 42924	0250	62572	Insert Plate for 42924	0900	35318	Wireclamp 6-2/2 AN for 42924	2140
35258	Blindplug 3/8" MS/VN for 42924	0255	35289	Vacuum Cover Complete for 42924	1010	35319	Rail JMV35SL 9-Hole 220mm for 42924	2150

Parts Breakdown

Model VP-NL-0040-MS 42924

Item No.	Description	Position	Item No.	Description	Position	Item No.	Description	Position
35320	Hex.Socket Head Cap Screw M4x8 DIN912 A2 for 42924	2170	15889	Sealbeam Single Seal L=500mm Complete for 42924	3100	35211	Hexagon Screw M8x16 DIN933 A2 for 42924	4050
34998	Flat Washer M4 D9021 A2 120/140 P32/ Carriage Ring M4 for 42924	2175	35346	Sealbeam DS/1/495 for 42924	3110	35372	Castle Washer M8 for 42924	4060
35322	Earth Terminal M4 1x45-GR for 42924	2180	35347	Sealbeam TS/1/495 for 42924	3120	35375	Nut M20x1.5 MS for 42924	4075
35323	Endplate Wire Connector for 42924	2190	35348	Sealbeam 8mm/1/495 for 42924	3130	35376	Cable Gland M20x1.5 Plastic for 42924	4080
35324	Seal Cord C1-07 for 42924	2200	27837	Hose (O2) Drago 6x13 for 42924	3290	35377	Lid Locker for 42924	4160
35325	Seal Cord KK C1-22 for 42924	2205	27836	Connecting Piece T-Piece 6mm for 42924	3310	35380	Slotted Cheese Head Screw M4x12 A2 DIN84 for 42924	4180
35326	Control Cable CC1-01 for 42924	2210	30019	Hose Clip Klemfa 12.8x14.8mm for 42924	3320	35381	Terminal Block 4-Pole for 42924	4200
35327	Network-Cord CM 1-11 for 42924	2220	35352	Cable Clamp 1x12mm DIN7257 for 42924	3330	35382	Cover Connection Block 4-Pole for 42924	4210
35328	Feed Main Switch CM2-04 for 42924	2230	35353	Self Tapping Screw PIAS 3.5x9.5 for 42924	3340	35383	Slotted Cheese Head Screw M4x16 A2 DIN84 for 42924	4220
35329	Pump Cord CM4-09 for 42924	2250	35354	Tube Alu 10x1mm L=400mm for 42924	3350	35384	Safety Clamp Vacuum Pump for 42924	4300
35330	Valve Cord CC2-02 for 42924	2260	35355	Cable Clip 1x10mm DIN72571 for 42924	3360	35387	Vac Pump 040-132 230/400-3-50 E for 42924	5010
35331	Cable Channel 40x40 for 42924	2280	31554	Adj Screw Soc Head M6x6 DIN916 A2 for 42924	3430	35388	Hose Clip ABA 32-44mm for 42924	5040
35332	Cable Microswitch for 42924	2290	15842	Silicone T-Profile 40 Shore One Meter for 42924	3490	15833	PVC Suction Hose HNA-32x42mm for 42924	5050
35333	WM01 Feed Transformer Primary for 42924	2300	35358	Conical Compression Spring for 42924	3580	35390	Pipe Nipple Half 1/2 1 for 42924	5060
35334	WM05 Looping Transformer Primary for 42924	2330	35359	Hexagon Bolt M6x40 DIN931 A2 for 42924	3590	35391	Adj.Screw/Soc.Head M8x25 DIN916 A2 for 42924	5070
35335	WM06 MAS Pump-Threading Clamp for 42924	2340	27824	Castle Washer M6 for 42924	3600, 3660	35219	Flat Washer M8 D9021 A2 for 42924	5080
35336	WM11 Pump Cable MAS-MBS 2.5 for 42924	2350	27787	Hexagon Screw M6x16 DIN933 A2 for 42924	3650, 4320	65754	Cover Protection 04-Control for 42924	9020
35337	WC04 Control Transformer Fuse-Clip for 42924	2360	35507	Holing Block Silicon Holder HD-03 for 42924	3690	65753	Cap Wide Holder 04-Control for 42924	9030
35338	WE02 Ground Cord Machine-PE 2.5 for 42924	2370	35364	O-Ring 27x2.5 for 42924	3700	27789	Slott.Rais.Counter.Head Screw M4x10 DIN7985 A2 for 42924	9040
35714	Interconnection Double MAS100C09 for 42924	2380	35365	Mounting Screw Holing Block HD-03 for 42924	3740	35419	Sticker Tension+Warning for 42924	9420
15936	Sealbag 3000800-K(KL)L=340mm for 42924	3010	35366	Spacer Sil.Holder Gas 42mm for 42924	3750	27794	Sticker Machine Type for 42924	9430
31553	Pressure Beam H-2000 for 42924	3030	35367	Bottom Section for 42924	4010	35223	Sticker 19x38 Yellow for 42924	9440
35342	Silicon Holder for 42924	3050	35368	Spring Control Box for 42924	4020	35224	Sticker 98x65 Yellow for 42924	9450
35343	Silicon Holder for 42924	3055	35369	Swivel Castor Black ST.ST. 100mm for 42924	4030			
35344	Sealing Mechanism for 42924	3060	35370	Fixed Castor ST.ST. for 42924	4040			



Warranty Registration

Thank you for purchasing an Omcan product. To register your warranty for this product, complete the information below, tear off the card at the perforation and then send to the address specified below. You can also register online by visiting:

Merci d'avoir acheté un produit Omcan. Pour enregistrer votre garantie pour ce produit, complétez les informations ci-dessous, détachez la carte au niveau de la perforation, puis l'envoyer à l'adresse spécifiée ci-dessous. Vous pouvez également vous inscrire en ligne en visitant:

Gracias por comprar un producto Omcan usted. Para registrar su garantía para este producto, complete la información a continuación, cortar la tarjeta en la perforación y luego enviarlo a la dirección indicada a continuación. También puede registrarse en línea en:

<https://omcan.com/warranty-registration/>

For mailing in Canada

Pour postale au Canada

Por correo en Canadá

OMCAN

PRODUCT WARRANTY REGISTRATION

3115 Pepper Mill Court,

Mississauga, Ontario

Canada, L5L 4X5

For mailing in the US

Pour diffusion aux États-Unis

Por correo en los EE.UU.

OMCAN

PRODUCT WARRANTY REGISTRATION

4450 Witmer Industrial Estates, Unit 4,

Niagara Falls, New York

USA, 14305

or email to: service@omcan.com



Purchaser's Information

Name: _____

Address: _____

City: _____ Province or State: _____ Postal or Zip: _____

Country: _____

Dealer from which Purchased: _____

Dealer City: _____ Dealer Province or State: _____

Invoice: _____

Model Name: _____ Model Number: _____

Machine Description: _____

Date of Purchase (MM/DD/YYYY): _____

Would you like to extend the warranty? Yes No

Company Name: _____

Telephone: _____

Email Address: _____

Type of Company:

Restaurant Bakery Deli

Butcher Supermarket Caterer

Institution (specify): _____

Other (specify): _____

Serial Number: _____

Date of Installation (MM/DD/YYYY): _____

Thank you for choosing Omcan | Merci d'avoir choisi Omcan | Gracias por elegir Omcan



Since 1951 Omcan has grown to become a leading distributor of equipment and supplies to the North American food service industry. Our success over these many years can be attributed to our commitment to strengthen and develop new and existing relationships with our valued customers and manufacturers. Today with partners in North America, Europe, Asia and South America, we continually work to improve and grow the company. We strive to offer customers exceptional value through our qualified local sales and service representatives who provide convenient access to over 6,500 globally sourced products.

Depuis 1951 Omcan a grandi pour devenir un des “leaders” de la distribution des équipements et matériel pour l’industrie des services alimentaires en Amérique du Nord. Notre succès au cours de ces nombreuses années peut être attribué à notre engagement à renforcer et à développer de nouvelles et existantes relations avec nos clients et les fabricants de valeur. Aujourd’hui avec des partenaires en Amérique du Nord, Europe, Asie et Amérique du Sud, nous travaillons continuellement à améliorer et développer l’entreprise. Nous nous efforçons d’offrir à nos clients une valeur exceptionnelle grâce à nos ventes locales qualifiées et des représentants de service qui offrent un accès facile à plus de 6500 produits provenant du monde entier.

Desde 1951 Omcan ha crecido hasta convertirse en un líder en la distribución de equipos y suministros de alimentos en América del Norte industria de servicios. Nuestro éxito en estos años se puede atribuir a nuestro compromiso de fortalecer y desarrollar nuevas relaciones existentes con nuestros valiosos clientes y fabricantes. Hoy con socios de América del Norte, Europa, Asia y América del Sur, que trabajan continuamente para mejorar y crecer la empresa. Nos esforzamos por ofrecer a nuestros clientes valor excepcional a través de nuestro local de ventas y representantes de los servicios que proporcionan un fácil acceso a más de 6,500 productos con origen a nivel mundial.

